

How to select resistors and avoid unforeseen stress factors

The First-ever LIVE Demo of resistor technologies: Thick Film, Thin Film, and Bulk Metal Foil will be compared by subjecting each resistor to Temperature, Load, Vibration, ESD ,Thermal EMF and Pulses.



There is More to Resistor Precision than Meets the Eye

- Resistors from different technologies may seem alike on the surface, and may often have similar published specifications (Initial TCR, Initial Tolerance, Load life stability, Noise, ESD, etc).
- However, each is made of a different resistive material and produced differently. Resistance material, design and processing variations strongly influence electrical performance, leading to different behaviors after installation.
- Resistor stability should be judged by real-life performance under load and temperature through short-term and long-term exposure to different electrical and mechanical stresses.

The Ideal Resistor

- When current passes through a resistor it generates heat, (Joule effect), and the thermal response induces relative mechanical changes (stresses) due to differential thermal expansions in the different materials comprising the resistor.
- Ambient temperature changes have a similar effect. Therefore the ideal resistor would employ materials and designs that minimize manufacturing stresses for a precise thermo-mechanical balance to eliminate the need to compensate for the effects of heat and stress during use.
- Furthermore, the ideal resistor should have no inductance and no capacitance.

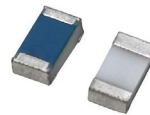

We Bring Our Technical Seminars To You

- VPG Foil Resistors offers seminars on the theory and practice of resistors, including physical and mechanical stress factors.
- We cover such subjects as temperature (known and unknown), pulse, amplifiers, CTE (coefficient of thermal expansion) of the PCB, ESD, surface tension, baking, thermal EMF, and much more.
- We offer free seminars at preselected sites, or we can come to you and provide training and seminars at your site. We can match the seminar to your needs. Bring your own resistors to the seminar for testing and discuss your specific application with trained experts.
- We promise to provide design tools to reduce your cost and at the same time maximize your circuit performance.

Main Reasons For Precision Resistor Malfunction

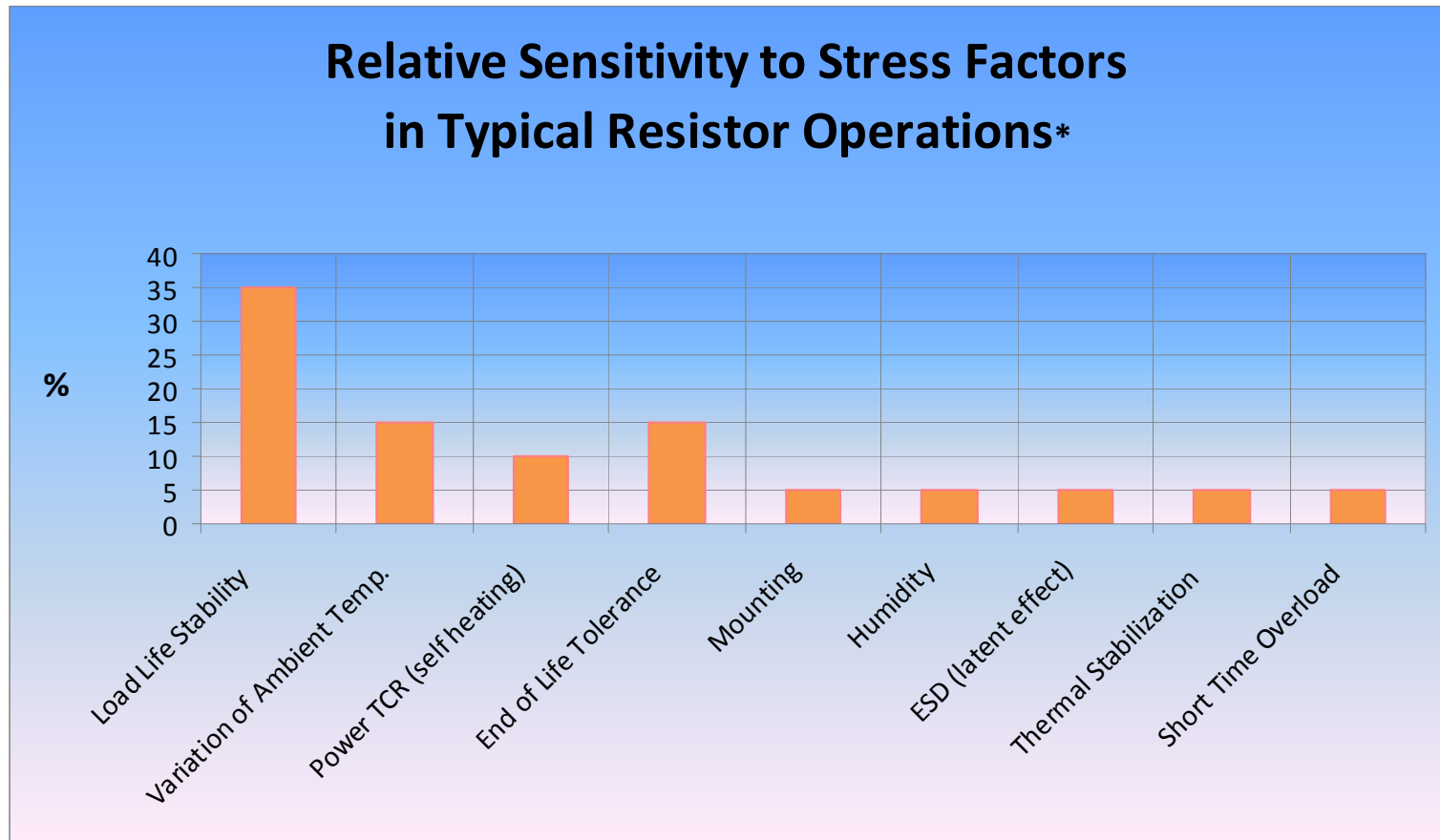

* VPG Foil Resistors estimates

Main Resistor Technologies

- Wirewound
- Thin Film
- Thick Film
- **Bulk Metal[®] conventional Foil**
- **Bulk Metal[®] Z-Foil**

Wirewound Resistors

- Precision wirewound resistors consist of resistance wire wound on a plastic or ceramic bobbin. The wire is spotwelded to outside copper leads and epoxy molded to protect it from the outside environment.
- Winding produces permanent deformation (not elastic) in the wire rendering it unstable. Prior to molding, the resistor is adjusted to the required ohmic value by abrading some of the wire. This operation and the prior winding method introduce potential failure sites and reduce reliability.
- Furthermore, abrading of wire may result in opens during resistor exposure to power, time and temperature. To stabilize the resistor, it is necessary to subject it to temperature cycling. However, this operation is only a partial cure and does not produce uniform results.



Thin Film

- Thin Film resistors consist of an extremely thin layer of resistive material (50 to 250 Angstroms) deposited on a ceramic or silicon substrate.
- Thin Film resistors have relatively limited surge capabilities such as ESD and short time overload due to the low mass of resistive material.
- For low values ($<10 \Omega$) stability issues arise with deposition and trimming of increased thickness of the alloy, for high values ($>1 M\Omega$) problems arise with uniformity and protection of reduced thickness.

Thin Film – cont.

- Various and complex factors contribute to the instability of thin-film resistors. These include lattice distortion, discontinuous aggregate formations, occlusion of gas at crystal interfaces, oxidation of the film to form oxide semiconductors and mechanical strains.
- Lateral laser trim produces “hot spots,” hence instability. The principal virtue of thin film resistors is that they can be used in high speed applications where precision may not be a major factor, and where small size (high ohm/square) and price are considerations .

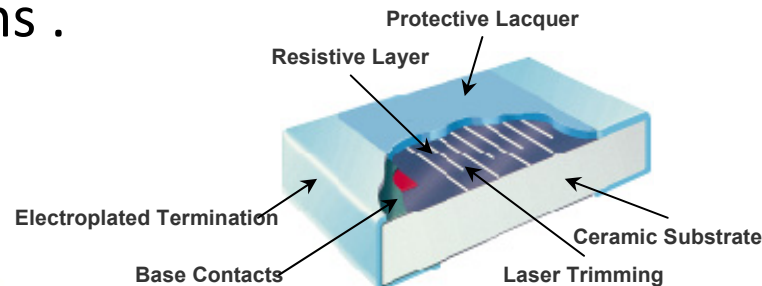

Thick Film

- Thick film resistors are comprised of ceramic based materials combined with metallic particles.
- The process involves firing the thick film resistive material to a solid ceramic substrate, thus providing a rugged base for resistors to withstand high surge conditions.
- Lateral trim produces current crowding and “hot spots.”
- It is the cheapest resistor on the market but it is relatively unstable with time, power and temperature as compared to Thin Film, Foil or Wirewound resistors.
- Thick Film resistors are not available in tight tolerances.

Bulk Metal[®] Foil Resistor

- The Bulk Metal Foil resistor is based on a special concept where a proprietary bulk metal cold-rolled Foil is cemented to a ceramic substrate.
- It is then photoetched into a resistive pattern (no mechanical stress introduced). Later, it is laser adjusted to any desired value and tolerance.
- Because the resistive metal used is not drawn, wound or mechanically stressed in any way during manufacturing process, the Bulk Metal Foil resistor maintains all its design, physical and electrical characteristics while winding of wire, or sputtering of thin films, or thick film glazing do not.

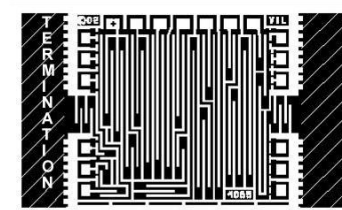

Bulk Metal[®] Foil Resistor – cont.

- The TCR of the Foil resistor is achieved by matching two opposing effects the inherent increase in resistance due to temperature increase vs. the compression - related decrease in resistance due to that same temperature increase.
- The two effects occur simultaneously resulting in an unusually low predictable, repeatable, and controllable TCR.

Illustration of the Foil Resistor Structure:

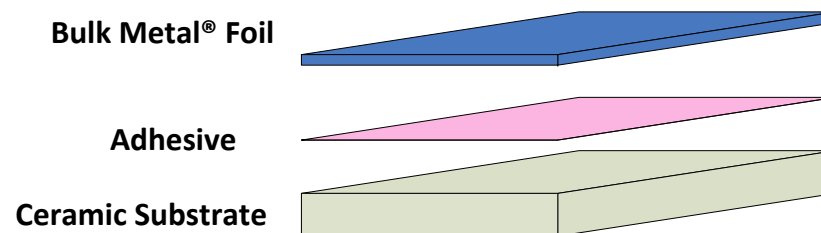

Bulk Metal® Foil Resistor – cont.

- Foil resistors achieve maximum stability and **near-Zero TCR**. This performance is built-in for every unit, and do not rely on screening or other artificial means for uniform performance.

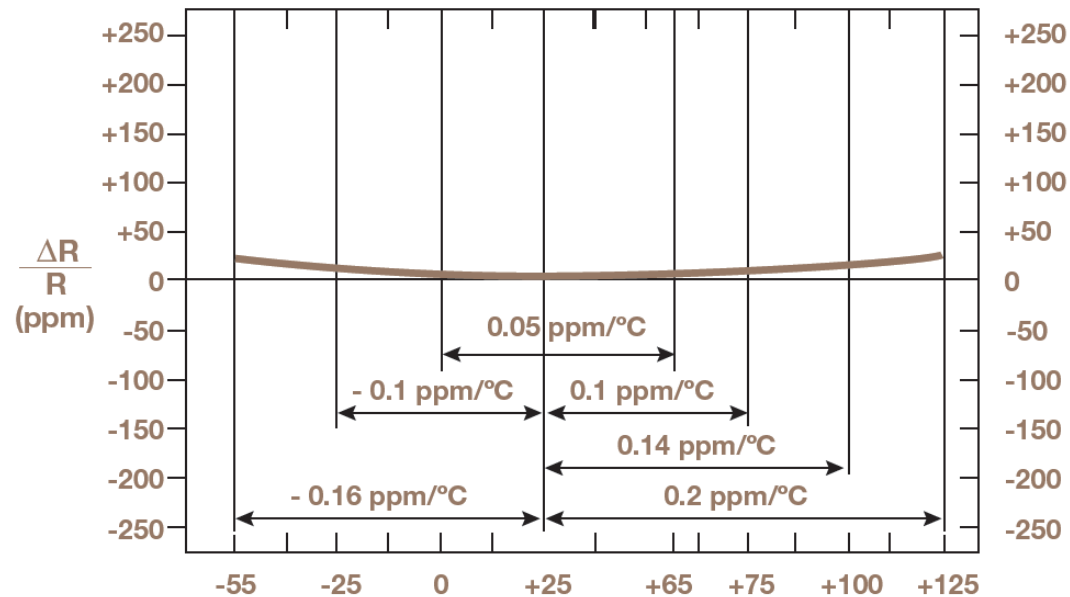

Ambient temperature coefficient and TCR chord slopes for different temperature ranges

Bulk Metal[®] Foil Resistor – cont.

Ruggedized Construction

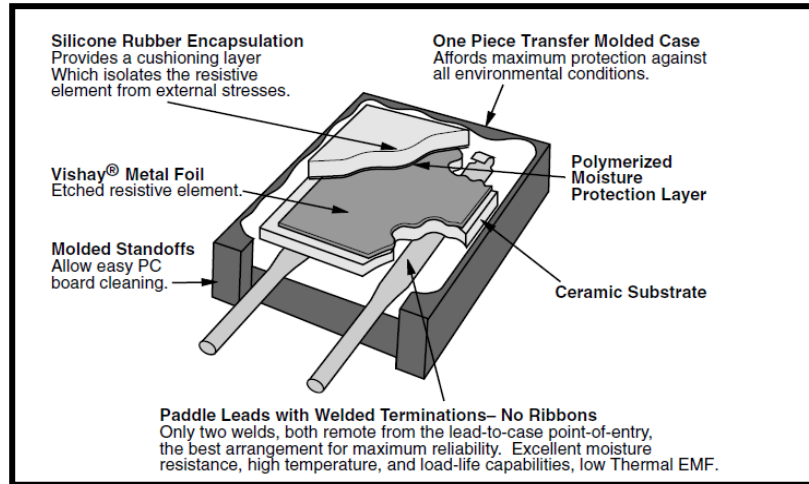

Surface-mount wrap-around chip Foil resistor construction

Thermal design of surface-mount chip foil resistor produces a resistor with extremely low thermal EMF.

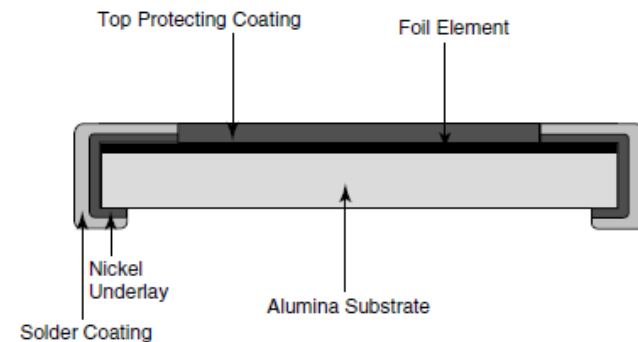

Unique Trimming Method of Foil Avoids Hot Spots

- How a resistor is trimmed has a significant effect on stability. Most resistors are trimmed or adjusted to achieve the desired resistance value, usually by having a laser that cuts the resistance pattern of thick, thin film or Foil. Unfortunately this can create a potential failure point where the current path is crowded around the laser's trim kerf.
- For wirewound resistors abrading of wire for calibration purposes contributes to instability and may produce opens.

Foil element- Trimming operations increase resistance in precise steps but from remote locations so that the etched grid in the active area remains reliable and noise-free. Furthermore the resistive pattern minimizes inductance and capacitance.

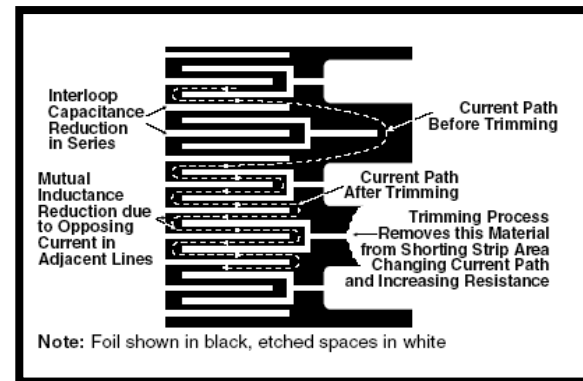

Characteristics of different types of resistors

Table 1. Characteristics of Different Types of Resistors

Technology	Temperature Coefficient of Resistance (TCR) - 55 °C to + 125 °C, + 25 °C Ref.	Initial Tolerance	End of Life Tolerance	Load-Life Sstability at + 70 °C, Rated Power 2000 Hours and 10,000 Hours	ESD (V)	Thermal Stabilization	Noise (dB)
Bulk Metal Foil	0.2 ppm/C	From 0.005 %	< 0.05 %	0.005 % (50 ppm) 0.01 % (100 ppm)	25,000	< 1 second	- 42
High Preicision Thin Film	5 ppm/C	From 0.05 %	< 0.4 %	0.05 % (500 ppm) 0.15 % (1500 ppm)	2500	> few minutes	- 20
Precision Thick Film	50 ppm/C	From 0.5 %	< 5 %	0.5 % (5000 ppm) 2 % (20,000 ppm)	2000	> few minutes	+ 20
Wirewound	3 ppm/C	from 0.005 %	< 0.5 %	0.05 % (500 ppm) 0.15 % (1500 ppm)	25,000	> few minutes	- 35

Demo Kit

Real-Time Simulation vs. PowerPoint Presentation

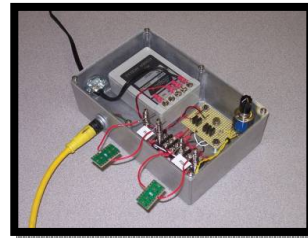

Four Temperature Factors

- There are four main factors which should be considered when designing a board:

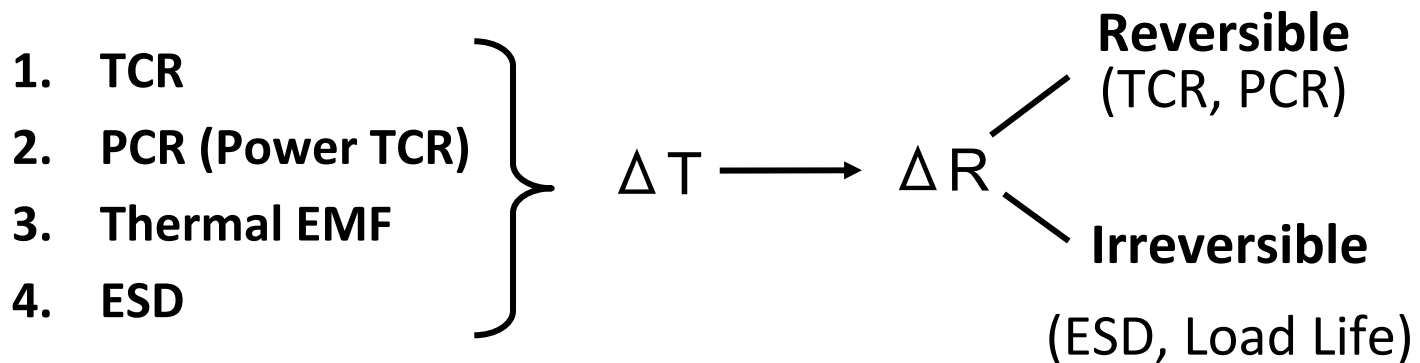

Temperature Coefficient of Resistance (TCR)

- Temperature Coefficient of Resistance (TCR) is the best known parameter used to specify a resistor's stability, and is used to depict the resistive element's sensitivity to temperature change due to ambient temperature variations.
- Temperature Coefficient of Resistance (TCR) = $\frac{\Delta R}{R_{ref} \Delta T}$
will show how resistors behave under cold operating temperatures and high operating temperatures.

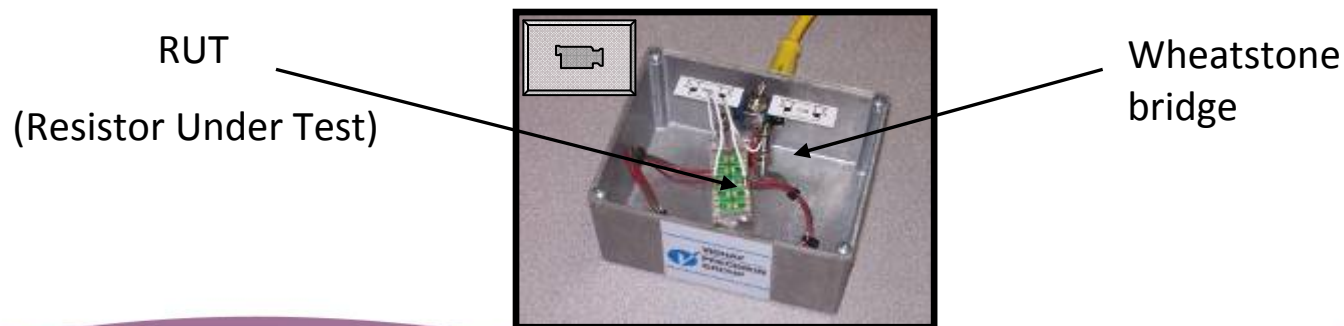

Power Coefficient of Resistance (PCR / Power TCR)

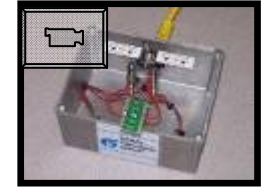

- Power Coefficient of Resistance (PCR) is a lesser-known, but still an extremely important parameter. This parameter quantifies the resistance change due to self-heating when power is applied. All the tested resistors are same size/value and tested under the same conditions.
- **Test 1:** Power Coefficient of Resistance for discrete resistor. During the test we apply power and measure the ΔR . The demonstration will illustrate the behavior of the resistors under applied power.
- **Test 2:** Tracking Power Coefficient of Resistance for resistor networks. We apply power to a voltage divider with two equal value resistors on the same substrate and measure the ΔR_2 - ΔR_1 ratio tracking.

Thermal EMF (Noise Source)

- Thermal EMF, which is negligible in ordinary resistors, may become a significant noise source of drift or instability in high-precision resistors for low resistance values DC applications, and is a parasitic effect interfering with pure resistance.
- It is often caused by the dissimilarity of the materials used in the resistor construction subject to external heat flow and/or to dissipated power.
- The thermal EMF performance of a resistor can be degraded by external temperature difference between the two junctions, dissymmetry of power distribution within the element, and the dissimilarity of the molecular activity of the metals involved.

Thermal EMF Test

- Thermal EMF (TEMF): when there is a temperature difference at the junction of two dissimilar metals such as the lead to resistive element termination, a voltage is generated.
- Across the thermocouple junction: this voltage can show up as an instability in low level DC circuits. We measure the thermal EMF voltage of several types of resistors.



Electrostatic Discharge (ESD)

Power
Supply

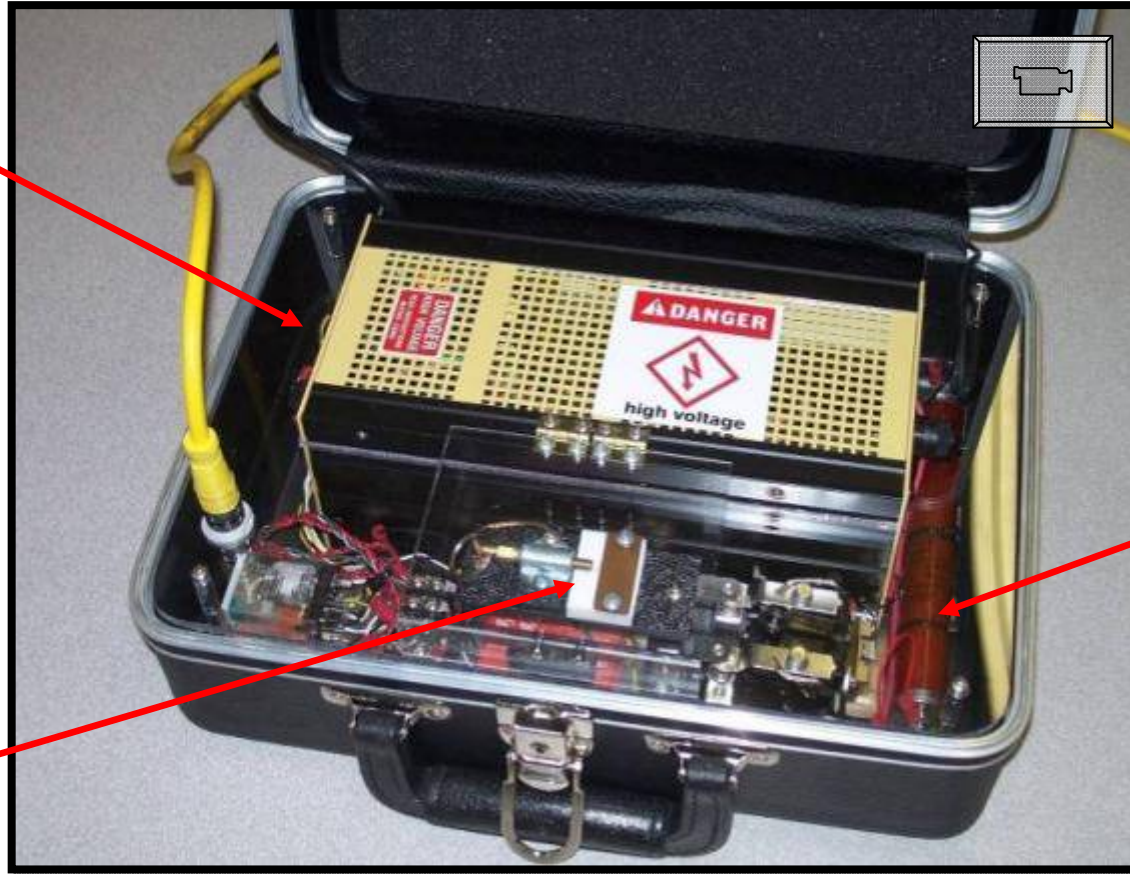

Capacitor

Device
Under
Test
(DUT)

ESD - Silent Killer of The Electronics Industry



- Electrostatic Discharge (ESD) damage to electronic devices can occur at any point in the component's life cycle, from manufacturing to field service. Generally, ESD damage is classified as either a catastrophic failure or latent defect. A catastrophic failure can be detected when the resistor is tested prior to shipment, but in the case of a latent defect, the damage will go undetected until the device fails in operation.
- A latent defect is more difficult to identify because a resistor that is exposed to an ESD event may be partially degraded, yet continue to perform its intended function. Premature parametric or catastrophic failure can occur after the resistor is already functioning in the finished product for a period of time.

ESD Test

- **Method 1**

We apply (in steps) up to 4500 V for 500 ns in each step, and measure the ΔR .

(Test data up to 25,000 V is available).

- **Method 2 (Latent Effect)**

We apply 10 pulses of 6000 V for 500 ns and measure the ΔR .

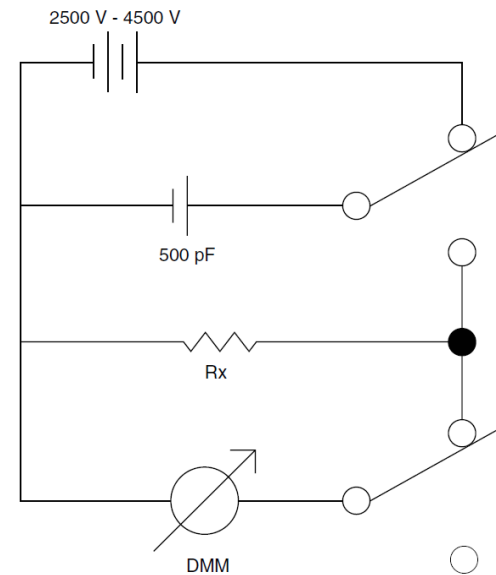

Short Time Overload (Load Life Acceleration)

- Short Time Overload (STO) occurs when a circuit is subjected at one point in time to a temporary, unexpected high pulse (or overload) that can result in device parametric or catastrophic failure. Simulation of load life stability as a function of Power, Temperature and Time. Short Time Overload (STO) is an accelerated simulation of load life stability.
- We apply high power for a short time, measure the ΔR , and correlate it to load life stability.

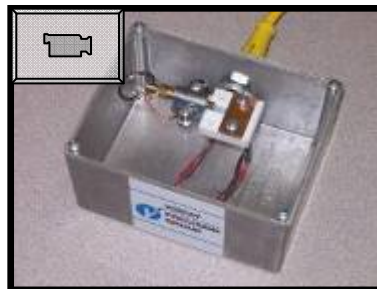

Current Sense: Do I need 2 or 4 Terminals (Kelvin connections)?

- Power pulse stability for low resistance values typically used in current sensing applications.
- We test 4 terminal Kelvin connection resistors and read the resistance change (ΔR) every 25 ms with increasing applied power up to 1 W.



Power Coefficient of Resistance for Low Values

Circuit diagram

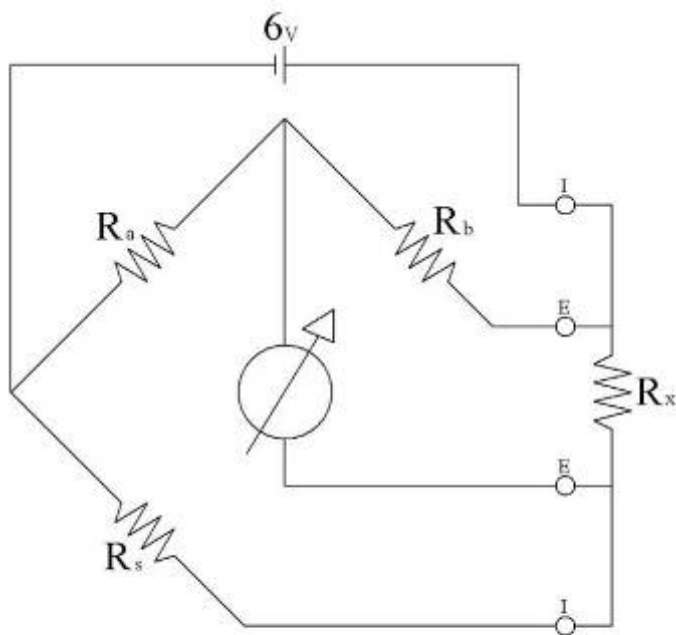

$R_b = 5 \text{ k}\Omega$
 $R_a = 1 \text{ k}\Omega$
 $R_s = 5 \text{ }\Omega$
 $R_x = 1 \text{ }\Omega$

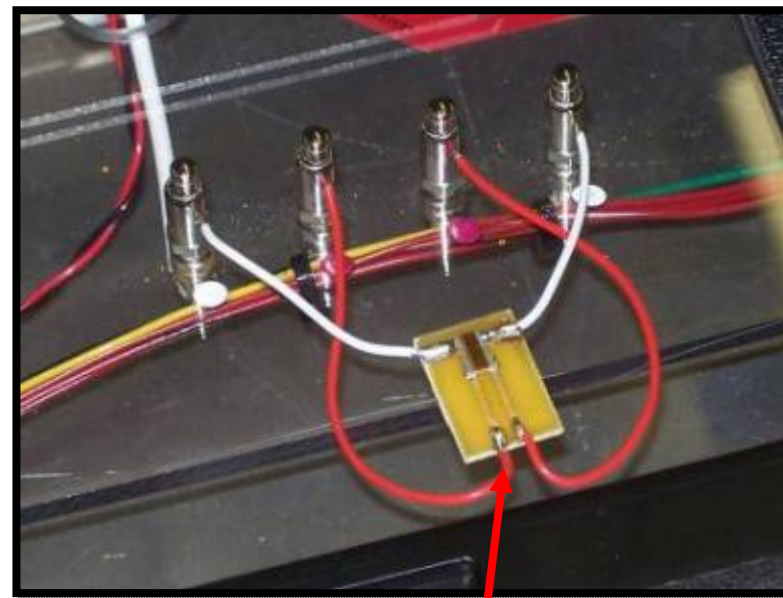

Kelvin Connections

Trimmers

- Trimmer settability and stability tests are performed comparing other resistor technologies:
 - **Contact Resistance Variation (CRV)**
Change in resistance is measured as the trimmer wiper is moved across the element and resistance variation from nominal is shown.
 - **Stability through the wiper**
Trimmers are set to the middle of wiper travel then vibration is applied for 30 seconds, we measure the resistance change and display the difference.
 - **Power TCR (ΔR due to power)**
PCR is measured through the wiper by applying increasing power and displaying the change in resistance.



Thermal Stabilization

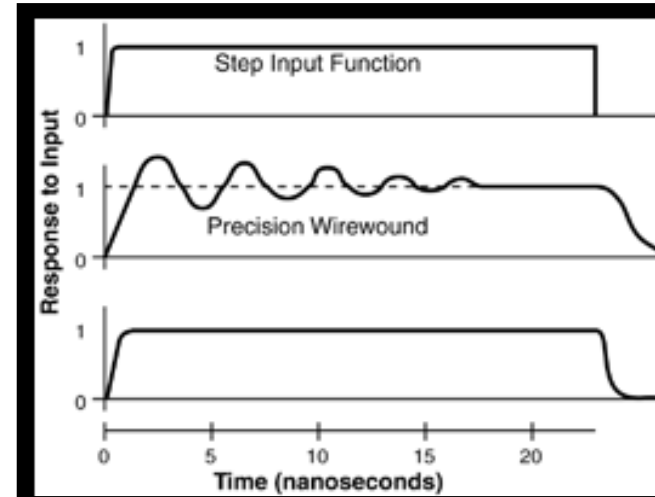
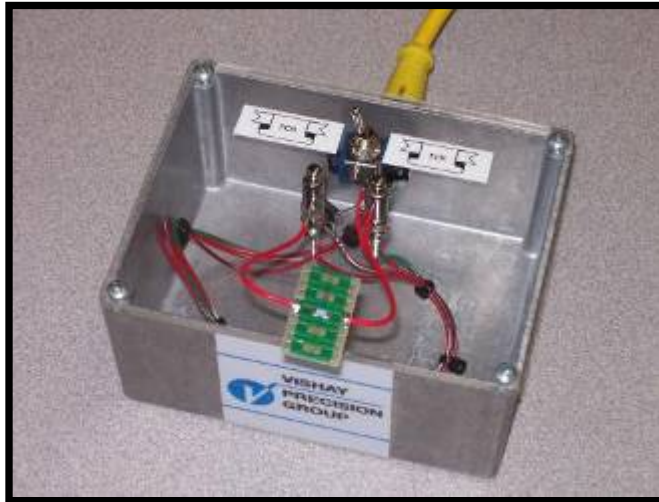

- An important factor for precision circuits is how quickly a resistor stabilizes at its final value after being subjected to its full rated power.
- Demonstration plots the ΔR of a test resistor under full-rated power from 0 – 3/10 seconds.

Amplifier

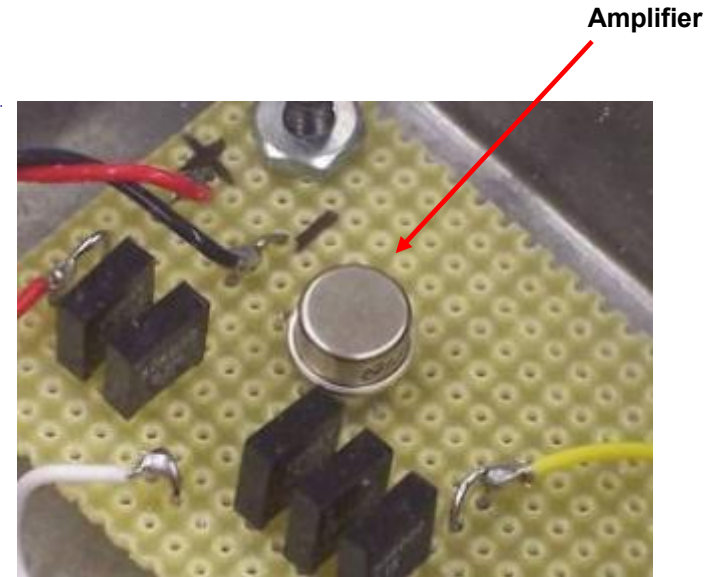
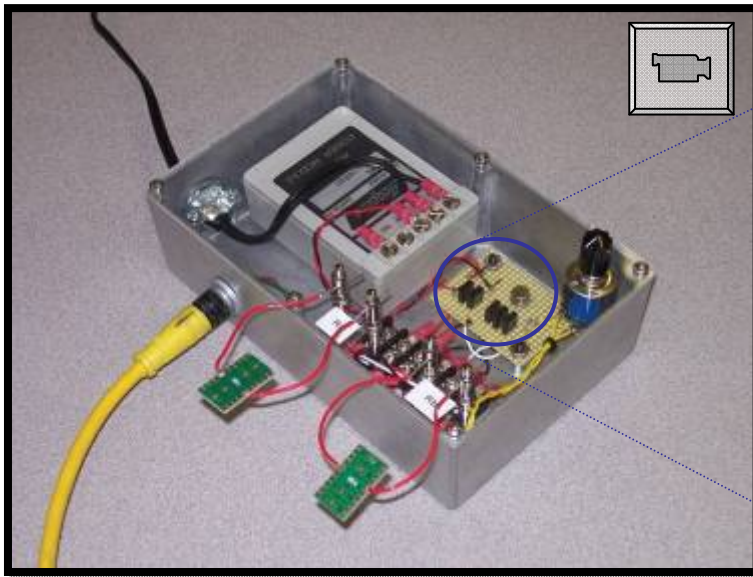

- Amplifier output stability is directly related to the stability of its input bias resistors.
- The demonstration shows amplifier output variations due to temperature change when resistors of different technologies are used as bias resistors.

Differential Amplifier

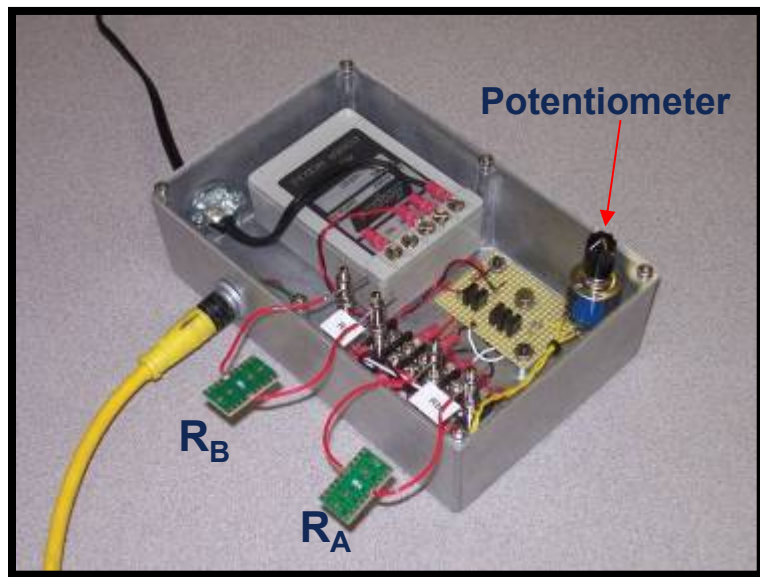

DIFFERENTIAL
AMPLIFIER

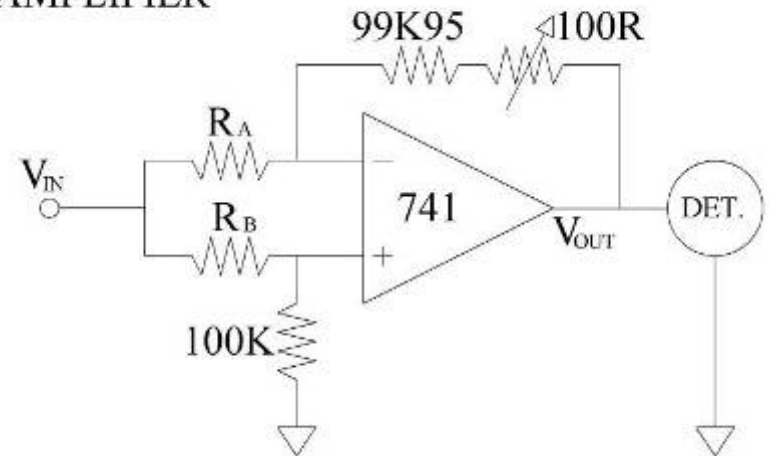

Calibration Station: No minimum quantity and any value within a few seconds



Calibration Station: No minimum quantity and any value within a few seconds



How Much Performance?

- Naturally, not every engineer needs an entire high-performance package for their circuitry. Resistors with much poorer specifications can be used satisfactorily in many applications, so the question of need is divided into four basic categories:
 1. Existing applications that can be upgraded by relying on the total performance package of Bulk Metal Foil resistors.
 2. Existing applications that require one or more, but not necessary all, of the performance parameters to be “industry best.”

How Much Performance?

3. State-of-the-art circuitry that can only be developed now because of the availability of improved specifications for precision resistors.
4. Purposeful pre-planning use of precision resistors to allow for future upgrading (e.g., cost savings can be realized by having the circuit accuracy maintained by the resistors rather than by the active devices, which would greatly increase cost for only slightly better levels of performance).

How Much Performance? Cont.

- In category two (2), for example, the need for a single parameter must be weighed against the economics of the whole package. It could cost less to use a resistor with superior overall performance specifications, because the need for compensating circuitry (and the cost of the associated components plus their assembly) may be eliminated. Cost savings may also be achieved by concentrating precision in the resistors rather than in the active devices, because active devices have greater cost per marginal performance improvement than the resistors do.

How Much Performance? Cont.

- Another question that might be posed is: “Would utilizing a higher-performance resistor in order to upgrade equipment performance enhance market acceptance of the equipment?”
- Does a better performance warrant a price increase of the improved equipment?

How To Order and Prototype Service

Get a quote



Standard Order



Foil Express



Door2door-Samples Service



Foil 24 - Next Day Delivery



Foil Accelerated



Precision Centers

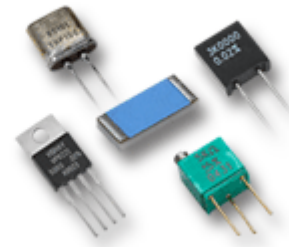

Credit Card





Foil Door2door - Service For Rapid Prototyping Samples

- When you need to evaluate 1 to 5 standard precision resistors for your prototype, you want them in a hurry. VPG Foil resistors now guarantees a 5 working day delivery on any value from 0R002 to 1M and any tolerance to 0.005%, per individual product specifications.
- There is no need to stock a wide array of R&D precision resistors at high minimum order prices when you can buy only what you need and get them within a few days. And, because the foil resistor is the most precise resistor available, it should satisfy all your R&D requirements.
- VPG will send the resistors directly from the main facility or via one of its precision centers or “Foil resistor quick delivery sources” that are spread around the world.

Europe

FAE TERRITORY KEY:		
UK/Spain	France/Italy	Germany/Poland
email: john.gardner@vishay.com	email: francois.morin@vishay.com	email: john.mohr@vishay.com
tel: +44 1246 810000	tel: +33 21 52 52 22	tel: +49 21 92 92 92
mobile: +44 781 500 000	mobile: +33 6 87 87 87 87	mobile: +49 172 500 000

Precision Centers: Contact: john.gardner@vishay.com Email: john.gardner@vishay.com Phone: +44 1246 810000 Fax: +44 1246 810000 Web: www.vishay.com Vishay Precision Group Europe Chesham, UK Precision - Vishay Germany Klein Olfers	Customer Service: Contact: john.gardner@vishay.com Email: john.gardner@vishay.com Phone: +44 1246 810000 Fax: +44 1246 810000 Web: www.vishay.com Vishay Precision Group Europe Chesham, UK Precision - Vishay Germany Klein Olfers	Sr. Sales Manager: Contact: john.gardner@vishay.com Email: john.gardner@vishay.com Phone: +44 1246 810000 Fax: +44 1246 810000 Web: www.vishay.com Vishay Precision Group Europe Chesham, UK Precision - Vishay Germany Klein Olfers
--	---	--



South America

FAE TERRITORY KEY:
Colombia
email: john.gardner@vishay.com
tel: +57 31 85 85 85
mobile: +57 31 85 85 85



North America

FAE TERRITORY KEY:		
US/Canada	UK/Canada	UK/Canada
email: john.gardner@vishay.com	email: john.gardner@vishay.com	email: john.gardner@vishay.com
tel: +1 949 542 3000	tel: +1 949 542 3000	tel: +1 949 542 3000
mobile: +1 949 542 3000	mobile: +1 949 542 3000	mobile: +1 949 542 3000

Precision Centers: Contact: john.gardner@vishay.com Email: john.gardner@vishay.com Phone: +1 949 542 3000 Fax: +1 949 542 3000 Web: www.vishay.com Vishay Precision Group North America San Diego, CA Vishay Precision Group North America San Diego, CA	Customer Service: Contact: john.gardner@vishay.com Email: john.gardner@vishay.com Phone: +1 949 542 3000 Fax: +1 949 542 3000 Web: www.vishay.com Vishay Precision Group North America San Diego, CA Vishay Precision Group North America San Diego, CA	Application Engineering: Contact: john.gardner@vishay.com Email: john.gardner@vishay.com Phone: +1 949 542 3000 Fax: +1 949 542 3000 Web: www.vishay.com Vishay Precision Group North America San Diego, CA Vishay Precision Group North America San Diego, CA
--	---	--



Asia and Israel

FAE TERRITORY KEY:	
Japan/China	India/Israel
email: john.gardner@vishay.com	email: john.gardner@vishay.com
tel: +81 3 5222 2222	tel: +91 2 2222 2222
mobile: +81 3 5222 2222	mobile: +91 2 2222 2222

Precision Center: Contact: john.gardner@vishay.com Email: john.gardner@vishay.com Phone: +81 3 5222 2222 Fax: +81 3 5222 2222 Web: www.vishay.com Vishay Precision Group Asia Tokyo, Japan	Customer Service: Contact: john.gardner@vishay.com Email: john.gardner@vishay.com Phone: +81 3 5222 2222 Fax: +81 3 5222 2222 Web: www.vishay.com Vishay Precision Group Asia Tokyo, Japan	Sr. Sales Manager: Contact: john.gardner@vishay.com Email: john.gardner@vishay.com Phone: +81 3 5222 2222 Fax: +81 3 5222 2222 Web: www.vishay.com Vishay Precision Group Asia Tokyo, Japan
--	--	---



For further information please
contact : foil@vishaypg.com

Visit us in our new website:
www.vishayfoilresistors.com